



Korenix – Your Embedded Networking & Computing Partner

Korenix, a Beijer Electronics Group Company is a market leading brand in industrial networking and embedded computing solutions with an extensive track record in providing innovative, market - oriented, value focused solutions to the industrial market.

Worldwide Recognition & International Awards

For excellence in products design and their outstanding performance, Korenix has achieved worldwide recognition and is continuously winning international awards, including COMPUTEX Best Choice Award in Year 2007, 2008, and 2009, IF Design Award 2009, Automation-2009 Award of AISS-Automata, Outstanding IT Products Award 2008, PRODUCT OF THE YEAR 2007 from Control Engineering, and Golden Penguin Award 2008. In 2009, Korenix JetBox is awarded Taiwan's Leading Product Sponsorship by the Taiwan Ministry of Economy. In 2010, Korenix has established its credibility by becoming a D&B D-U-N-S Registered™ Enterprise as well as being granted a 2010 Standard Chartered SME Elite award with a listing among Top 500 SME's of Taiwan.



Patent Technologies

2006

- Rapid Super Ring
- Dual Homing
- Tracked Switch Casing Machinery

2007

- Multiple Super Ring with MultiRing, TrunkRing, AnyRing
- Seamless Ring Restoration with ZERO Restoration Time
- Rapid Dual Homing II
- Waterproof Switch Casing Machinery

2008

- 6-in-1 Communication Computer
- Encrypted auto-run customization setting for the devices
- Monitoring and auto-recovery for applications

2009

- 24V to 48V PoE Boost Technology
- Fast Recovery Mechanism for Trunk Ring

2009

- A Fast Redundant Path Moving Mechanism for Network Coupling
- Initial Setup Method for Ring Network, Broken Link Redundancy Procedure and Restoration Method for Reconnected Broken Link
- Ring Network Coupling and its Redundant Procedure
- Power over Ethernet System Having Hi-Pot Isolation and Automatic Output (pending)
- Power Adjustment with Thermal Control (pending)

2010

- Distribute Power Management Device
- Network Protocol Speedup Classification Method
- Two way Booster PoE switch card: PCI add-on card or stand-alone switch card (pending)
- Serial Data Buffer for broken Uplink Ethernet Connection (pending)
- Security SD card with a key to trigger users' programs (pending)

Vertical Market Certifications

For vertical market application, Korenix products are designed and compliant with different approvals.

- IEC 61850 for Power Substation
- NEMA TS2 for Intelligent Transportation System
- EN50155 for Rolling Stock
- UL508 for Industrial Environment

Associations



Embedded Platforms for all applications



		JetCard Series	JetBox 3300	JetBox 5300	JetBox 5400	JetBox 8000	JetBox 9300	JetBox 9400	JetBox 9500
Network	Ethernet link only	<input type="radio"/>	<input checked="" type="radio"/>	<input checked="" type="radio"/>	<input checked="" type="radio"/>	<input checked="" type="radio"/>	<input checked="" type="radio"/>	<input checked="" type="radio"/>	<input checked="" type="radio"/>
	Ethernet Switch	<input type="radio"/>			<input checked="" type="radio"/>		<input checked="" type="radio"/>	<input checked="" type="radio"/>	<input checked="" type="radio"/>
	Router	<input type="radio"/>					<input checked="" type="radio"/>	<input checked="" type="radio"/>	<input checked="" type="radio"/>
	Power over Ethernet	<input type="radio"/>					<input checked="" type="radio"/>		<input checked="" type="radio"/>
Interface	Serial	<input type="radio"/>	<input checked="" type="radio"/>	<input checked="" type="radio"/>	<input type="radio"/>	<input checked="" type="radio"/>	<input checked="" type="radio"/>	<input type="radio"/>	<input type="radio"/>
	USB	<input type="radio"/>	<input checked="" type="radio"/>	<input checked="" type="radio"/>	<input checked="" type="radio"/>	<input checked="" type="radio"/>	<input checked="" type="radio"/>	<input checked="" type="radio"/>	<input checked="" type="radio"/>
	DIO		<input type="radio"/>	<input checked="" type="radio"/>			<input checked="" type="radio"/>	<input checked="" type="radio"/>	<input checked="" type="radio"/>
	CF card slot					<input checked="" type="radio"/>	<input checked="" type="radio"/>	<input checked="" type="radio"/>	<input checked="" type="radio"/>
	SD card slot			<input checked="" type="radio"/>			<input checked="" type="radio"/>	<input checked="" type="radio"/>	<input checked="" type="radio"/>
	microSD card slot		<input checked="" type="radio"/>						
	HD slot					<input checked="" type="radio"/>			
	miniPCIe & SIM card slot					<input type="radio"/>		<input type="radio"/>	<input type="radio"/>
OS	Embedded Linux (Korenix JetOS)	<input type="radio"/>	JetOS93 lite	JetOS93 lite	JetOS95		JetOS93 w/ Web UI	JetOS95	JetOS95
	Linux	<input type="radio"/>				<input type="radio"/>			
	WinCE					<input type="radio"/>			
	XPe					<input type="radio"/>			
	WES 2009					<input type="radio"/>			
	Windows	<input type="radio"/>							
	Programmable		<input checked="" type="radio"/>	<input checked="" type="radio"/>	<input checked="" type="radio"/>	<input type="radio"/>	<input type="radio"/>	<input checked="" type="radio"/>	<input checked="" type="radio"/>
	SDK provided		<input checked="" type="radio"/>	<input checked="" type="radio"/>	<input checked="" type="radio"/>	<input type="radio"/>	<input type="radio"/>	<input checked="" type="radio"/>	<input checked="" type="radio"/>
Add-on SW	Modbus gateway		<input type="radio"/>	<input type="radio"/>		<input type="radio"/>	<input type="radio"/>	<input type="radio"/>	<input type="radio"/>
	Webmin & JamVM							<input type="radio"/>	<input type="radio"/>
Environ.	-40~80°C op. temp.		<input checked="" type="radio"/>	<input checked="" type="radio"/>	<input checked="" type="radio"/>		<input type="radio"/>	<input type="radio"/>	
Applied Applications	Automotive engineering	<input type="radio"/>	<input checked="" type="radio"/>	<input checked="" type="radio"/>	<input checked="" type="radio"/>	<input checked="" type="radio"/>	<input checked="" type="radio"/>	<input checked="" type="radio"/>	<input checked="" type="radio"/>
	Telecommunications	<input type="radio"/>			<input checked="" type="radio"/>		<input type="radio"/>	<input checked="" type="radio"/>	<input checked="" type="radio"/>
	Industrial controls	<input type="radio"/>	<input checked="" type="radio"/>	<input checked="" type="radio"/>	<input checked="" type="radio"/>	<input checked="" type="radio"/>	<input checked="" type="radio"/>	<input checked="" type="radio"/>	<input checked="" type="radio"/>
	Mobile data acquisition							<input type="radio"/>	<input type="radio"/>
	Traffic engineering	<input type="radio"/>	<input checked="" type="radio"/>	<input checked="" type="radio"/>	<input checked="" type="radio"/>	<input checked="" type="radio"/>	<input checked="" type="radio"/>	<input checked="" type="radio"/>	<input checked="" type="radio"/>
	Building automation	<input type="radio"/>	<input checked="" type="radio"/>	<input checked="" type="radio"/>	<input checked="" type="radio"/>	<input checked="" type="radio"/>	<input checked="" type="radio"/>	<input checked="" type="radio"/>	<input checked="" type="radio"/>
	Fieldbus systems		<input checked="" type="radio"/>	<input checked="" type="radio"/>		<input type="radio"/>	<input checked="" type="radio"/>	<input type="radio"/>	<input type="radio"/>

● supported ○ supported by model

JetOS, Korenix Embedded Linux Platform with Abundant Developer Resources for Network Applications

Reliable and Stable Linux Platform for Network Application

Korenix JetOS is a stable, reliable Linux based operating system for the JetBox series. By pre-installing, configuring and completing integration testing with JetOS, time to market is cut dramatically for user application development. Creating networking and control applications is simplified using pre-installed Linux utilities, components and libraries. Remote access, user account management, and advanced security and networking features such as VPN and layer 3 routing can easily be configured with JetOS out of the box.

Small Footprint with System Scalability

Unlike Linux running on PC, Korenix JetOS is an optimized embedded Linux platform in Kernel and file system to have small footprint. In addition, JetOS does not have the limitation on flash storage size like other embedded Linux. Instead, JetOS adjusts the structure of Linux file system intelligently to allocate multiple system storage sources. The core Linux Kernel is stored on flash with written protection whereas applications can be stored in external CF or SD card.

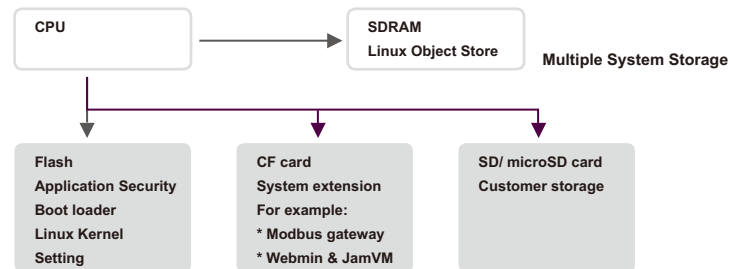

Powerful Technical Capabilities and Built-In Networking SW Packages

With the inherited advantages of powerful technical capabilities of open source Linux, Korenix JetOS is built-in and tested with different networking software utilities and packages for routing or ethernet switching functionality. Korenix JetOS significantly reduces development time and time to market for systems integrators or SW developers.

Developer SDK for Customization

Developer SDK is provided with JetBox including cross compiler and sample code. With the SDK, developers can easily modify the sample code to generate their own control and networking applications.

File Security for Developer's Program

Application files can be encrypted by an authorized key on an optional security CF card to make sure the applications are well-protected from illegal usage or copying.

JetBox 3300-w / 3350i-w Programmable

Compact size for small front-end control systems

- Embedded Linux ready for easy maintenance
- Linux SDK for quick time-to-market
- Dual Ethernet ports for system uplink redundancy
- Dual USB for data storage
- 2 Serial, 16 DIO for device and signal control
- 2KV Serial Isolation for device protection
- One microSD card slot for customized configurations
- Modbus gateway (optional)
- -40~80°C wide operating temperature for harsh environments



CE FC RoHS

JetBox 3300-w Interface

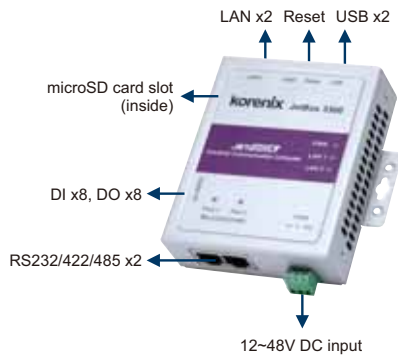

JetBox 3350i-w Interface

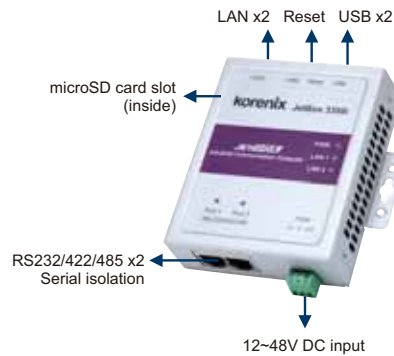

JetBox 3300-w

Linux Computer w/ 16 DIO

- Ethernet x2
- USB x2
- microSD x1
- RS232/422/485 x2
- DI x8, DO x8



JetBox 3350i-w

Linux Computer w/ Isolated Serial

- Ethernet x2
- USB x2
- microSD x1
- RS232/422/485 x2 with 2KV isolation



JetBox 5300-w Programmable

Ruggedized Embedded System for Network Application

- RISC Processor with low power consumption for reliable performance
- Embedded Linux ready for easy maintenance
- SD card slot for customized configuration
- 4DI & 4DO for digital device connections
- 4 Serial ports for device remote control
- Dual Ethernet for system uplink redundancy
- Modbus gateway (optional)
- Dual redundant power inputs for system reliability
- -40~80°C wide operating temperature for harsh environments



CE FC RoHS

JetBox 5430-w / 5432-w Programmable

Ruggedized Embedded System for Network Application

- VPN, DMVPN for enhanced secure networking
- Complete Layer3 Routing: OSPF, RIP, DVMRP, IPv6
- QoS and port-based VLAN for full switch management
- Embedded Linux ready for easy maintenance
- 5 Ethernet ports for high network connectivity
- 4 Serial ports for device remote control
- -40~80°C wide operating temperature for harsh environments



CE FC RoHS

JetBox 5000 Series Interface

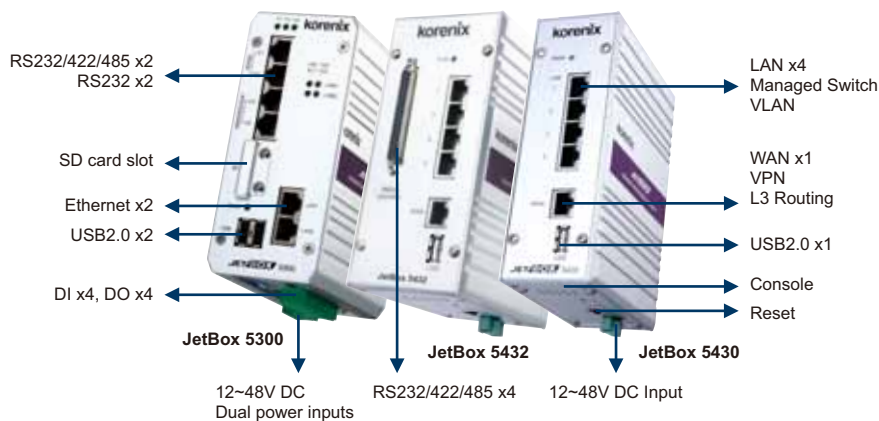

Quick Selection Guide



JetBox 5300-w



JetBox 5430-w



JetBox 5432-w

		Basic	VPN	VPN + Serial
Network	Ethernet link	x2		
	Ethernet Switch (LAN)	○	x4	x4
	Router (WAN)		x1	x1
Interface	RS232/422/485	x2		x4
	RS232	x2		
	USB	x2	x1	x1
	DIO	DI x4, DOx4		
	SD card slot	x1		
OS	Embedded Linux	Korenix JetOS93 lite	Korenix JetOS95	
Add-on SW	Modbus Gateway	○		
Environ.	-40~80°C op. temp.	○	○	○

○ supported by model



SW Specification

Korenix JetOS93 lite

Bootloader: JetBox bootloader

Linux Kernel: 2.6.21

Shell: GNU ash

File system: JFFS2, NFS, Ext2, Ext3, VFAT, FAT

Device drivers: microSD card, USB, Watchdog timer, UART, Ethernet

Protocol: ARP, PPP, CHAP, IPv4, PAP, ICMP, TCP, UDP, NFS

Software packages: busybox (telnetd, inetd, udhcp, syslogd), diocfg, lrzsz, minicom, microcom, ncurses, ser2net, setserial, bridge-utils, ethtool, goahead web server, iptables, net-snmp, ntp, openssh, openssl, pppd, ftpd, rp-pppoe, smtpclient, wireless-tools

Korenix Linux auto-run function

Customized configuration

Process monitoring

SDK

Linux tool chain: Gcc (C/C++ PC

cross compiler), uClibc, libstdc++

Linux sample code

Korenix JetOS95 (without IO extension)

Bootloader: JetBox bootloader

Linux Kernel: 2.6.20

Shell: GNU ash

File system: jffs2, NFS, Ext2, Ext3, VFAT, FAT

Device drivers: USB, Watchdog timer, UART, Ethernet, DIO, PoE, SD/mSD card, CF card, HW IPsec VPN, HW Open VPN, JetCard1608/ 2105/ 2154G, VGA*, Mobile dongle*, GPS dongle*

Protocols: ARP, PPP, CHAP, IPv4, IPv6, PAP, ICMP, TCP, UDP, NFS, SNMP v1/v2c/v3, NTP, SSH1.0/2.0, SSL, OpenVPN, Ipsec, PPP, PPPoE, PPTP, FTP, HTTP, SMTP, DNS, L2TP, DVMP, OSPF, RIP v1.0/2.0, BGP*, ISIS*, VRRP*, 802.11*, HSDPA*, GPRS* telnet, dhcp, VLAN

SW package: Busybox (telnetd, inetd, udhcp, syslogd), e2fsprogs, firmware, i2c-tools, microcom, mtd, netcat, pciutils, ser2net, setserial, ssdutil, usbmount, usbutils, version, bridge-utils, ethtool, iptables, net-snmp, ntp, openssh, openssl, openvpn, openswan, pppd, rp-pppoe, pptp-linux, proftpd, samba, goahead, mutt, bind, l2tp, mrouterd, quagga, vrrpd, wireless-tools, wvdial

Korenix Linux auto-run function

Customized configuration

Process monitoring

SDK

Linux tool chain: Gcc(C/C++ PC cross compiler),

uClibc

Linux sample code

Note: Software supports differ from HW functions of each model

JetBox 9300 series Linux auto-run

Powerful All-in-One System for Data Gateway

- Double Award-Winning Embedded System
- 1 WAN, 4 LAN for static routing: NAT, DMZ
- Full switch management with QoS, VLAN
- 4-port PoE delivers full 15.4W per port
- 2-port RS232/422/485 and 2 RS232, supporting VCOM, TCP server/client, UDP and paired TCP modes
- USB for wireless data transmission
- Easy management with DIO, PoE Scheduling
- SNMP v1, v2c, v3 for easy network management
- NTP for network time management
- Linux SDK for quick time-to-market
- Auto-run SD card for customized configuration
- -40~80°C wide operating temperature for harsh environments (JetBox 9300-w / 9310-w)



JetBox 9310 Interface

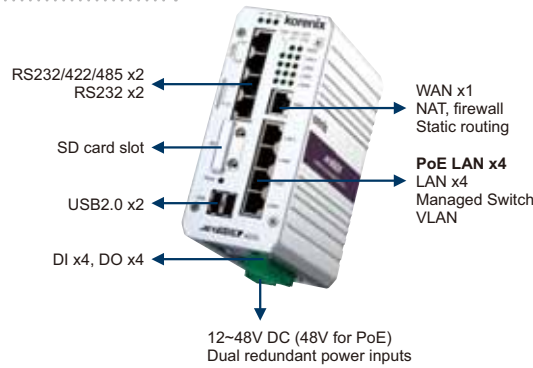

JetBox 9300 Interface

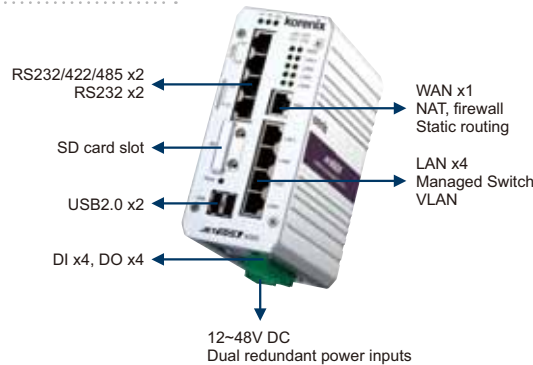

Quick Selection Guide



JetBox 9300 (-w)



JetBox 9310 (-w)

		All-in-One	+PoE
Network	(PoE) Ethernet Switch (LAN)	LAN x4	PoE LAN x4
	Router (WAN) Static routing	x1	x1
Interface	RS232/422/485	x2	x2
	RS232	x2	x2
	USB	x2	x2
	DIO	DI x4, DO x4	DI x4, DO x4
	SD card slot	x1	x1
OS	Embedded Linux	Korenix JetOS93 with Korenix WebUI & CLI	
Add-on SW	Modbus Gateway	<input type="radio"/>	<input type="radio"/>
	Power input	DC 12~48V input / 48V for PoE	
Environ.	-40~80°C op. temp.	<input type="radio"/>	<input type="radio"/>

- supported
- supported by model



PoE: Power over Ethernet; -w: wide temp. model

Control by Korenix Web UI & CLI

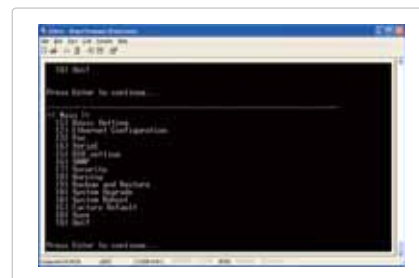

JetBox 9400 series Programmable MSR

Embedded Routing Platform for Secured Multi-Site Communications

- VPN, DMVPN for enhanced secure networking
- Complete Layer3 Routing: OSPF, RIP, DVMRP, IPv6
- Embedded Linux UI—Modulized Webmin
- Linux SDK provided for programming
- Multiple Interface: WAN, LAN, DIO, USB, Serial
- 12~48 VDC wide range power input
- Multiple Super Ring (MSR) network redundancy for reliable data transmission
- Gigabit for High Bandwidth data transmission
- Full switch management with QoS, VLAN
- NTP for network time management
- miniPCle & SIM slot for mobile module (GSM/GPRS/3G/HSUPA)
- Auto-run SD card for customized configuration
- -40~80°C wide operating temperature for harsh environments



JetBox 9432 Interface

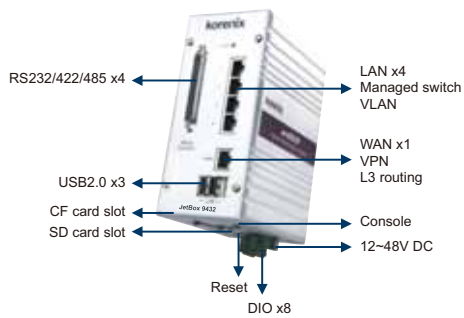

JetBox 9432G Interface

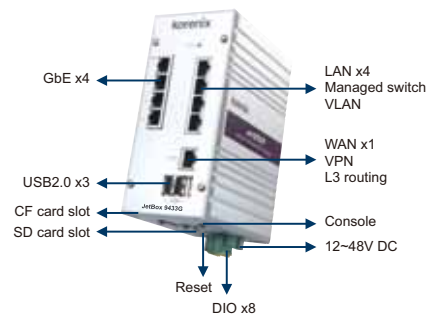

JetBox 9462 Interface

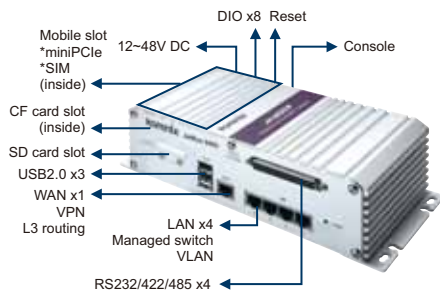

JetBox 9462G Interface

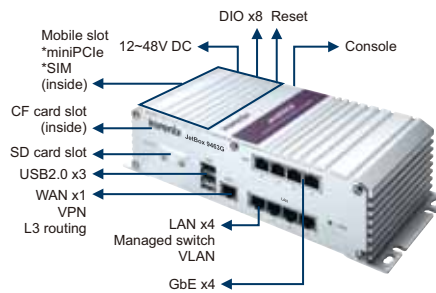

Quick Selection Guide



JetBox 9430 JetBox 9432 JetBox 9433G JetBox 9435 JetBox 9460 JetBox 9462 JetBox 9463G

		Basic	+Serial	+GbE	+4 LAN	+Mobile	+Mobile +Serial	+Mobile +GbE
Network	Ethernet Switch (LAN)	FE x4	FE x4	FE x4 GbE x4	FE x8	FE x4	FE x4	FE x4 GbE x4
	Router (WAN)	x1	x1	x1	x1	x1	x1	x1
Interface	RS232/422/485		x4				x4	
	USB	x3	x3	x3	x3	x3	x3	x3
	DIO	x8	x8	x8	x8	x8	x8	x8
	CF card slot	x1	x1	x1	x1	x1	x1	x1
	SD card slot	x1	x1	x1	x1	x1	x1	x1
	miniPCle & SIM slot					x1	x1	x1
OS	Embedded Linux	Korenix JetOS95						
Add-on SW	Modbus Gateway		○				○	
	MSR	○	○					
	Webmin & JamVM	○	○	○	○	○	○	○
Environ.	-40~80°C op. temp.	○	○	○	○	○	○	○

● supported ○ supported by model

FE: Fast Ethernet; GbE: Gigabit Ethernet



SW Specification

Korenix JetOS 95 (without PoE)

Bootloader: JetBox bootloader

Linux Kernel: 2.6.20

Shell: GNU ash

File system: jffs2, NFS, Ext2, Ext3, VFAT, FAT

Device drivers: USB, Watchdog timer, UART, Ethernet, DIO, PoE, SD/mSD card, CF card, HW IPsec VPN, HW Open VPN, JetCard1608/ 2105/ 2154G, VGA*, Mobile dongle*, GPS dongle*

Protocols: ARP, PPP, CHAP, IPv4, IPv6, PAP, ICMP, TCP, UDP, NFS, SNMP v1/v2c/v3, NTP, SSH1.0/2.0, SSL, OpenVPN, Ipsec, PPPoE, PPTP, FTP, HTTP, SMTP, DNS, L2TP, DVMRP, OSPF, RIP v1.0/2.0, BGP*, ISIS*, VRRP*, 802.11*, HSDPA*, GPRS* telnet, dhcp, VLAN

SW package: Busybox (telnetd, inetd, udhcp, syslogd), e2fsprogs, firmware, i2c-tools, microcom, mtd, netcat, pciutils, ser2net, setserial sstutil, usbmount, usbutils, version, bridge-utils, ethtool, iptables, net-snmp, ntp, openssh, openssl, openvpn, openswan, pppd, rp-pppoe,

pptp-linux, proftpd, samba, goahead, mutt, bind, l2tp, mROUTED, quagga, vrrpd, wireless-tools, wvdial

WebUI (optional) includes:

Webmin by Korenix: DIO, PoE, Device Server (TCP Server mode), DHCP, DMVPN, DVMRP, Firmware Upgrade, GPRS, Modbus Gateway*, Module Upgrade, OSPF, RIP, Switch Port, VLAN

Webmin basic / Webmin system

Webmin servers / Webmin others

JamVM (optional)

Korenix Linux auto-run function

Customized configuration

Process monitoring

SDK

Linux tool chain: Gcc/C/C++ PC cross compiler), uClibc

Linux sample code

Note: Software supports differ from HW functions of each model

JetBox 9500 series Programmable MSR

Embedded PoE Routing Platform for Advanced Multi-Site or Vehicle Application

- VPN, DMVPN for enhanced secure networking
- Complete Layer3 Routing: OSPF, RIP, DVMRP, IPv6
- Embedded Linux UI—Modulized Webmin
- Linux SDK provided for programming
- Multiple Interface: WAN, LAN, DIO, USB, Serial
- 48V PoE ports with 15.4W per port for IP surveillance
- 12~24VDC Power booster for vehicle surveillance (JetBox9560 series)
- Multiple Super Ring (MSR) network redundancy for reliable data transmission
- Gigabit for High Bandwidth video stream transmission
- Full management with QoS, VLAN, PoE Scheduling
- NTP for network time management
- miniPCIe & SIM slot for mobile module (GSM/GPRS/3G/HSUPA)
- Auto-run SD card for customized configuration



JetBox 9530 Interface

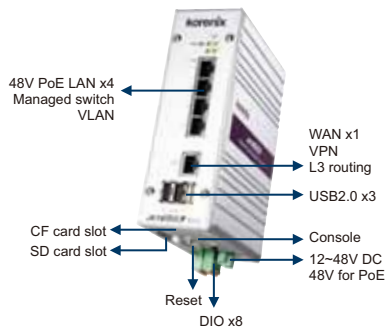

JetBox 9535 Interface

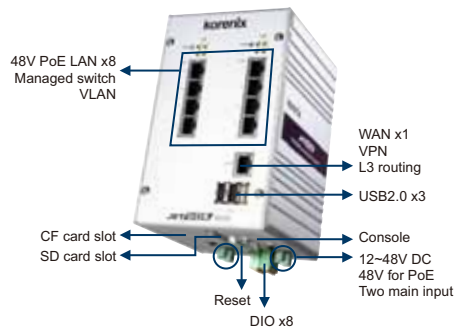

JetBox 9560 Interface

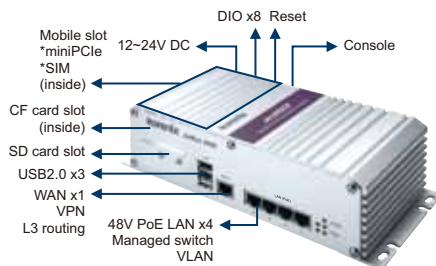

JetBox 9562 Interface

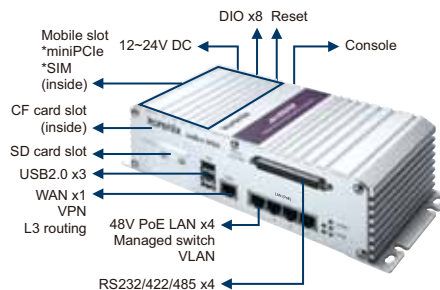

Quick Selection Guide



JetBox 9530 JetBox 9532 JetBox 9533G JetBox 9535 JetBox 9560 JetBox 9562 JetBox 9563G

	Basic	+Serial	+GbE	+4 PoE	+Mobile	+Mobile +Serial	+Mobile +GbE
Network	(PoE) Ethernet Switch (LAN)	PoE x4	PoE x4	PoE x4 GbE x4	PoE x8	PoE x4	PoE x4
	Router (WAN)	x1	x1	x1	x1	x1	x1
Interface	RS232/422/485		x4				x4
	USB	x3	x3	x3	x3	x3	x3
	DIO	x8	x8	x8	x8	x8	x8
	CF card slot	x1	x1	x1	x1	x1	x1
	SD card slot	x1	x1	x1	x1	x1	x1
	miniPCIe & SIM slot				x1	x1	x1
OS	Embedded Linux						Korenix JetOS95
Add-on SW	Modbus Gateway		○				○
	MSR	○	○		○		
	Webmin & JamVM	○	○	○	○	○	○
Environ.	-25~70°C op. temp.	○	○	○	○	○	○

● supported ○ supported by model

PoE: Power over Ethernet; GbE: Gigabit Ethernet



SW Specification

Korenix JetOS 95 (with PoE)

Bootloader: JetBox bootloader

Linux Kernel: 2.6.20

Shell: GNU ash

File system: jffs2, NFS, Ext2, Ext3, VFAT, FAT

Device drivers: USB, Watchdog timer, UART, Ethernet, DIO, PoE, SD/mSD card, CF card, HW IPsec VPN, HW Open VPN, JetCard1608/ 2105/ 2154G, VGA*, Mobile dongle*, GPS dongle*

Protocols: ARP, PPP, CHAP, IPv4, IPv6, PAP, ICMP, TCP, UDP, NFS, SNMP v1/v2c/v3, NTP, SSH1.0/2.0, SSL, OpenVPN, Ipsec, PPP, PPPoE, PPTP, FTP, HTTP, SMTP, DNS, L2TP, DVMRP, OSFP, RIP v1.0/2.0, BGP*, ISIS*, VRRP*, 802.11*, HSDPA*, GPRS* telnet, dhcp, VLAN

SW package: Busybox (telnetd, inetd, udhcp, syslogd), e2fsprogs, firmware, i2c-tools, microcom, mtd, netcat, pciutils, ser2net, setserial, sddutil, usbmount, usbutils, version, bridge-utils, ethtool, iptables, net-snmp, ntp, openssh, openssl, openvpn, openswan, pppd, rppoe, pptp-linux, proftpd, samba, goahead, mutt,

bind, l2tp, mroute, quagga, vrrpd, wireless-tools, wvdial

WebUI (optional) includes:

Webmin by Korenix: DIO, PoE, Device Server (TCP Server mode), DHCP, DMVPN, DVMRP, Firmware Upgrade, GPRS, Modbus Gateway*, Module Upgrade, OSPF, RIP, Switch Port, VLAN

Webmin basic / Webmin system

Webmin servers / Webmin others

JamVM (optional)

Korenix Linux auto-run function

Customized configuration

Process monitoring

SDK

Linux tool chain: Gcc(C/C++ PC cross compiler), uClibc

Linux sample code

Note: Software supports differ from HW functions of each model

JetBox 8000 series

High-Speed Embedded PC for Multimedia Display & Digital Signage

- Intel Atom 1.6GHz processor (JetBox 8180)
- Built-in media processor for high performance multimedia (JetBox 8150/8152)
- Multiple Interfaces – USB, Ethernet, Serial for flexible applications
- DVI with dual display and VGA interface for field site monitoring
- CANbus (SJA1000 CAN controller): error correction, high noise immunity
- Gigabit for high bandwidth data transmission
- XPe/WES2009/WinCE/Linux for flexible applications
- Linux Fedora with VPN is Ready-to-Use & Cost-Saving
- SATA Hard Drive/CF card for storage expansion
- miniPCle & SIM slot for mobile module (GSM/GPRS/3G/HSUPA)
- 5g for vibration resistance and 50g for shock resistance



CE FC RoHS

JetBox 8000 Series Interface

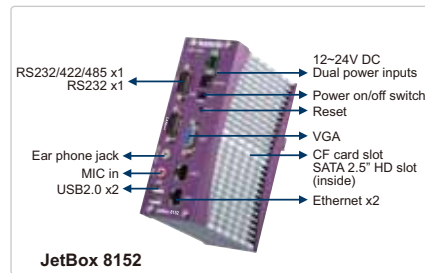
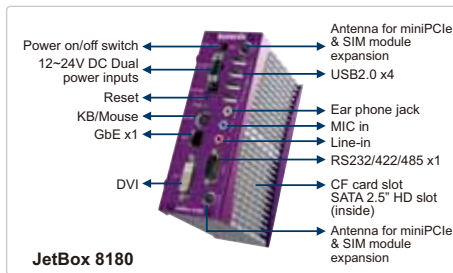

Quick Selection Guide



	X86 1GHzw/DVI			
Network	Ethernet link only	LAN x2	LAN x2	GbE x1
Interface	Serial, CANbus, DIO	Serial x2	Serial x1, CANbus x1	Serial x1
	USB	x2	x2	x4
	VGA, DVI	VGA	VGA	DVI (dual display option)
	2.5" HD slot	SATA x1, CF x1	SATA x1, CF x1	SATA x1, CF x1
OS	Linux	○	○	○
	WinCE	○	○	○
	XPe	○	○	○
	WES 2009	○	○	○
Extension	Optional HW & SW			Mini-PCle & SIM slot
	Power input	DC 12~24V	DC 12~24V	DC 12~24V

○ supported by model



JetCard series

JetCard 5400-w

PCI-104 Single Board Computer for Enhanced Industrial Control



CE FC

- Intel IXP 435 Processor for enhanced routing
- 1 WAN, 4 LAN for flexible network connectivity
- VPN for long-distance and secure networking
- Pre-installed embedded Linux
- Linux SDK for customized applications
- -40~80°C wide op. temp.

JetCard 5010GP

Embedded Single Board Switch for Managed System Expansion



CE FC

- 8 LAN for high network connectivity
- 2 Gigabit SFP Combo for High-speed, long-distance connection
- 9K Jumbo Frame for large packets
- Port trunk for bandwidth aggregation
- 5 MultiRings for network redundancy
- LLDP, JetView Pro, SNMP, IGMP, QoS, VLAN, DHCP for efficient management
- -25~70°C wide op. temp.

JetCard 1608

PCI-104 Serial cards



CE FC

- RS232/422/485 x4 & RS232 x4 for access device connectivity
- Windows drivers for flexible computing
- -25~70°C wide op. temp.

JetCard 2105

PCI-104 Ethernet Switch cards



CE FC

- 5 LAN ports for flexible network connectivity
- Linux & Windows drivers for flexible computing
- -25~70°C wide op. temp.

JetCard 2154G

PCI-104 Gigabit Switch cards



CE FC

- 4 Gigabit ports for High Speed Connection
- Linux & Windows drivers for flexible computing
- -25~70°C wide op. temp.

JetCard 2205

UPCI Ethernet Switch cards



CE FC

- LAN x4 + Internal LAN x1 for flexible network connectivity
- -25~70°C wide op. temp.

JetCard 2215

UPCI PoE Switch cards



CE FC

- 12~24V Booster PoE for vehicle surveillance
- 48V PoE x4 + LAN x1 for IP camera connectivity
- 2 working modes: UPIC add-on card & standalone switch for flexible expansion
- -25~70°C wide op. temp.